

➤ General Description

This PAN40TY24AY N-Channel enhancement mode power field effect transistor is the high density trench technology and this advanced technology can provide excellent $R_{ds}(On)$ performance and efficiency for power switching and load switching application., this device also comply with the RoHS and Green Product requirement with full function reliability approved.

➤ Feature

- Super Low Gate Charge
- 100% EAS Guaranteed
- Green Device Available
- Excellent CdV/dt effect decline
- Advanced high cell density Trench technology

➤ DFN5X6A-EP1

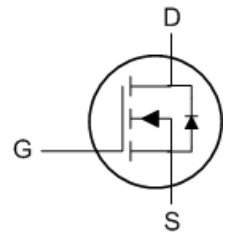
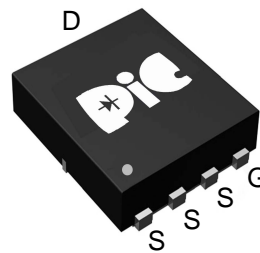

➤ Application

- DC/DC Primary Side Switch
- Industrial Synchronous
- Rectification Load Switch
- DC/DC Converters

➤ Absolute Maximum Ratings

Parameter	Symbol	Rating	Units
Drain-Source Voltage	V_{DS}	40	V
Gate-Source Voltage	V_{GS}	± 20	V
Continuous Drain Current ^{1,6}	$I_D@T_C=25^\circ C$	85	A
Continuous Drain Current ^{1,6}	$I_D@T_C=100^\circ C$	67	A
Pulsed Drain Current ²	I_{DM}	250	A
Single Pulse Avalanche Energy ³	EAS	125	mJ
Avalanche Current	I_{AS}	50	A
Total Power Dissipation ⁴	$P_D@T_C=25^\circ C$	83	W
Storage Temperature Range	T_{STG}	-55 to 150	$^\circ C$
Operating Junction Temperature Range	T_J	-55 to 150	$^\circ C$
Thermal Resistance Junction-Ambient ¹	$R_{\theta JA}$	62	$^\circ C/W$
Thermal Resistance Junction-Case ¹	$R_{\theta JC}$	1.5	$^\circ C/W$

➤ Electrical Characteristics ($T_J=25^\circ C$ Unless otherwise noted)

Parameter	Symbol	Conditions	Min.	Typ.	Max.	Unit
Drain-Source Breakdown Voltage	BV_{DSS}	$V_{GS}=0V$, $I_D=250\mu A$	40	---	---	V
Static Drain-Source On-Resistance ²	$R_{DS(ON)}$	$V_{GS}=10V$, $I_D=30A$	---	2.5	3.3	$m\Omega$
Gate Threshold Voltage	$V_{GS(th)}$	$V_{GS}=V_{DS}$, $I_D=250\mu A$	2	---	4	V
Drain-Source Leakage Current	I_{DSS}	$V_{DS}=48V$, $V_{GS}=0V$, $T_J=25^\circ C$	---	---	1	μA
		$V_{DS}=48V$, $V_{GS}=0V$, $T_J=55^\circ C$	---	---	5	
Gate-Source Leakage Current	I_{GSS}	$V_{GS}=\pm 20V$, $V_{DS}=0V$	---	---	± 100	nA
Forward Transconductance	g_{fs}	$V_{DS}=5V$, $I_D=30A$	---	53	---	S
Gate Resistance	R_g	$V_{DS}=0V$, $V_{GS}=0V$, $f=1MHz$	---	0.8	---	Ω
Total Gate Charge (10V)	Q_g	$V_{DS}=32V$, $V_{GS}=10V$, $I_D=20A$	---	65	---	nC
Gate-Source Charge	Q_{gs}		---	24	---	
Gate-Drain Charge	Q_{gd}		---	21	---	
Turn-On Delay Time	$T_{d(on)}$	$V_{DD}=20V$, $V_{GS}=10V$, $R_G=3.3\Omega$, $I_D=30A$	---	26	---	ns
Rise Time	T_r		---	38	---	
Turn-Off Delay Time	$T_{d(off)}$		---	63	---	
Fall Time	T_f		---	20	---	
Input Capacitance	C_{iss}	$V_{DS}=15V$, $V_{GS}=0V$, $f=1MHz$	---	4711	---	pF
Output Capacitance	C_{oss}		---	869	---	
Reverse Transfer Capacitance	C_{rss}		---	367	---	

➤ Diode Characteristics

Parameter	Symbol	Conditions	Min.	Typ.	Max.	Unit
Continuous Source Current ^{1,5}	I_S	$V_G=V_D=0V$, Force Current	---	---	20	A
Diode Forward Voltage ²	V_{SD}	$V_{GS}=0V$, $I_S=1A$, $T_J=25^\circ C$	---	---	1.2	V
Reverse Recovery Time	t_{rr}	$I_F=30A$, $dI/dt=100A/\mu s$,	---	20.3	---	nS
Reverse Recovery Charge	Q_{rr}	$T_J=25^\circ C$	---	9.5	---	

Note :

1. Pulse width limited by maximum junction temperature.
2. The data tested by pulsed, pulse width $\leq 300\mu s$, duty cycle $\leq 2\%$
3. The EAS data shows Max. rating. The test condition is $V_{DD}=25V$, $V_{GS}=10V$, $L=0.1mH$, $I_{AS}=50A$
4. Ensure that the channel temperature does not exceed $150^\circ C$.
5. The data is theoretically the same as I_D and I_{DM} , in real applications, should be limited by total power dissipation.
6. Package limitation current is 85A.

➤ Typical Characteristics

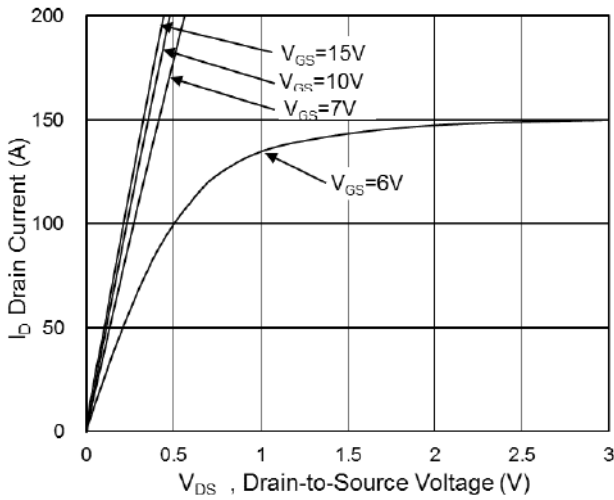

Fig.1 Typical Output Characteristics

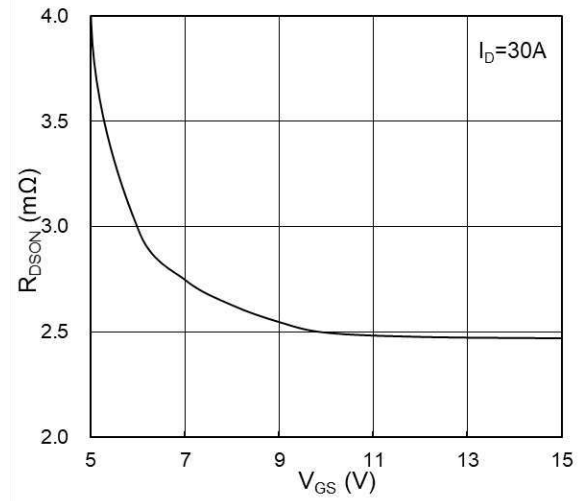

Fig.2 On-Resistance vs G-S Voltage

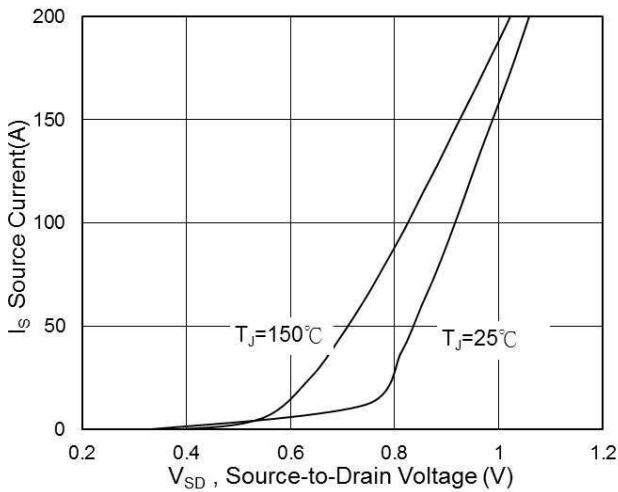

Fig.3 Source Drain Forward Characteristics

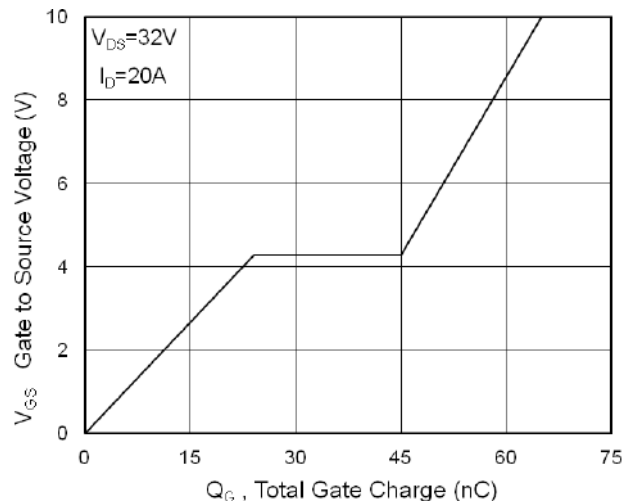

Fig.4 Gate-Charge Characteristics

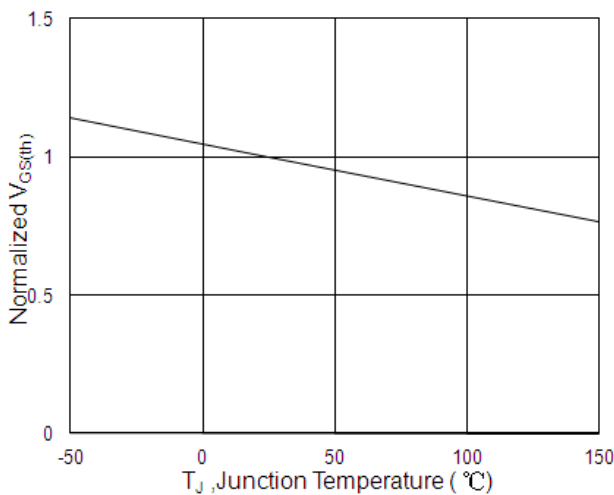

Fig.5 Normalized $V_{GS(th)}$ vs T_J

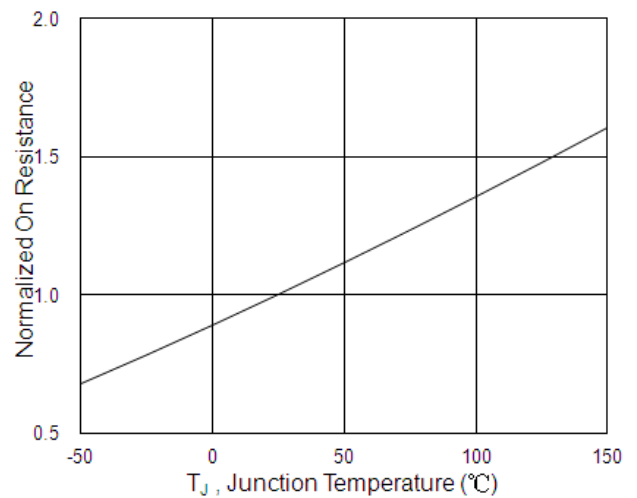

Fig.6 Normalized $R_{DS(on)}$ vs T_J

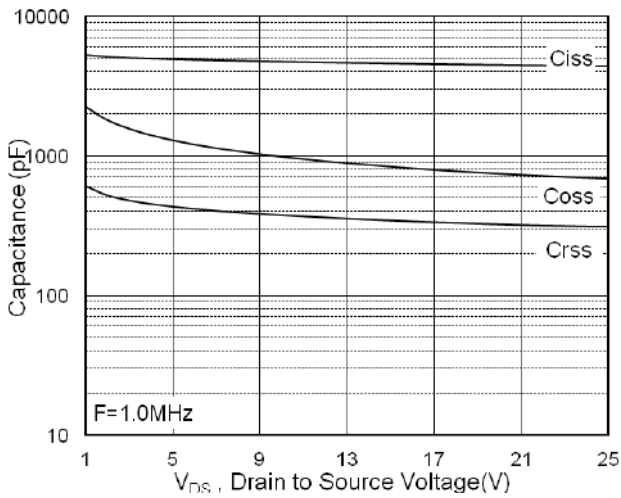

Fig.7 Capacitance

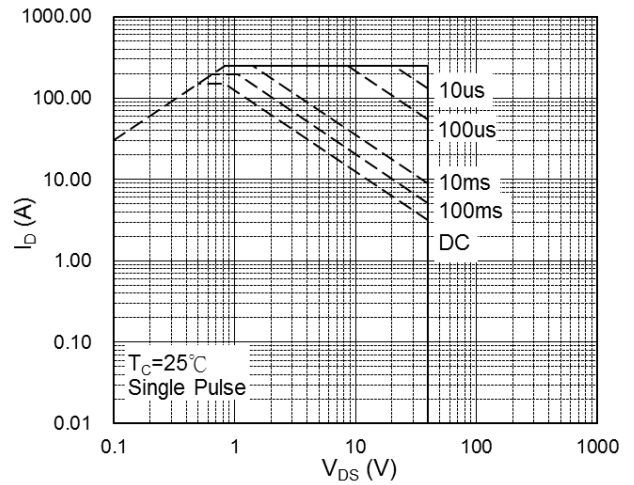

Fig.8 Safe Operating Area

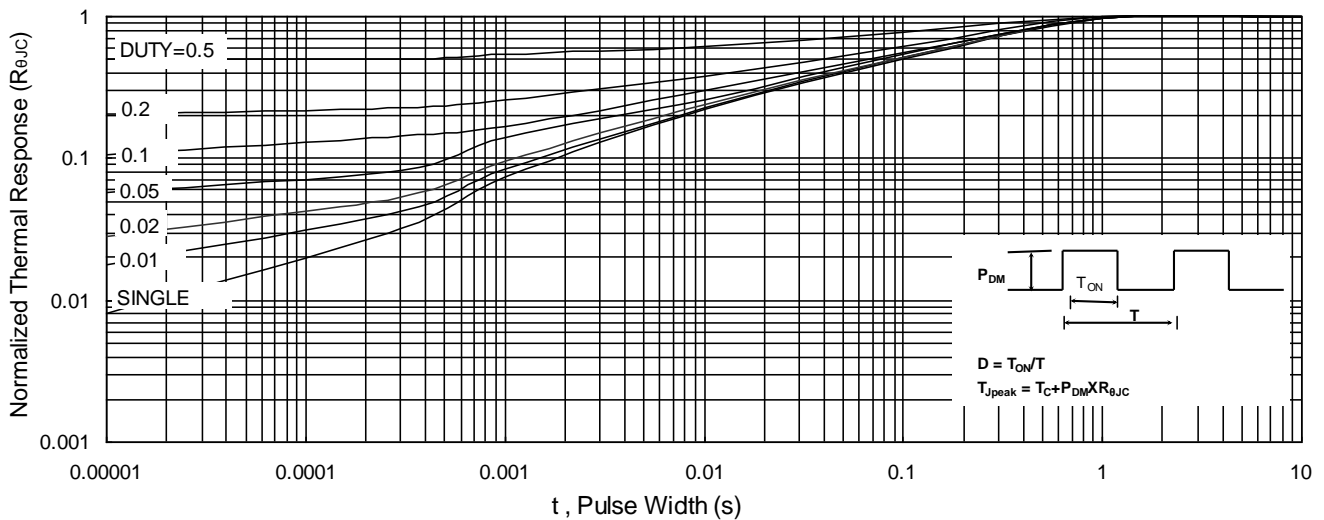

Fig.9 Normalized Maximum Transient Thermal Impedance

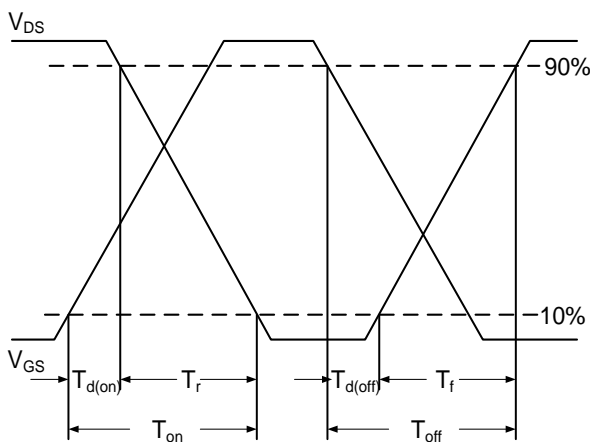

Fig.10 Switching Time Waveform

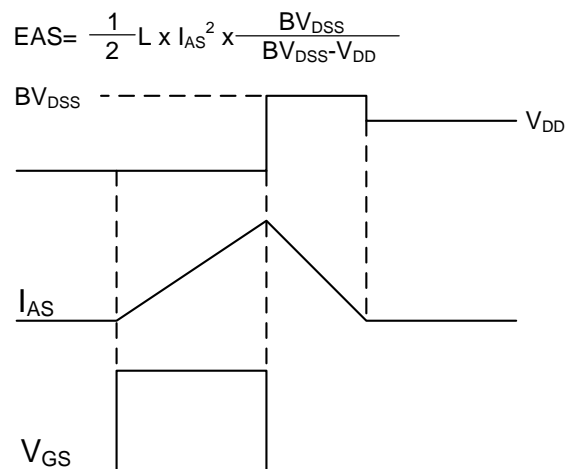
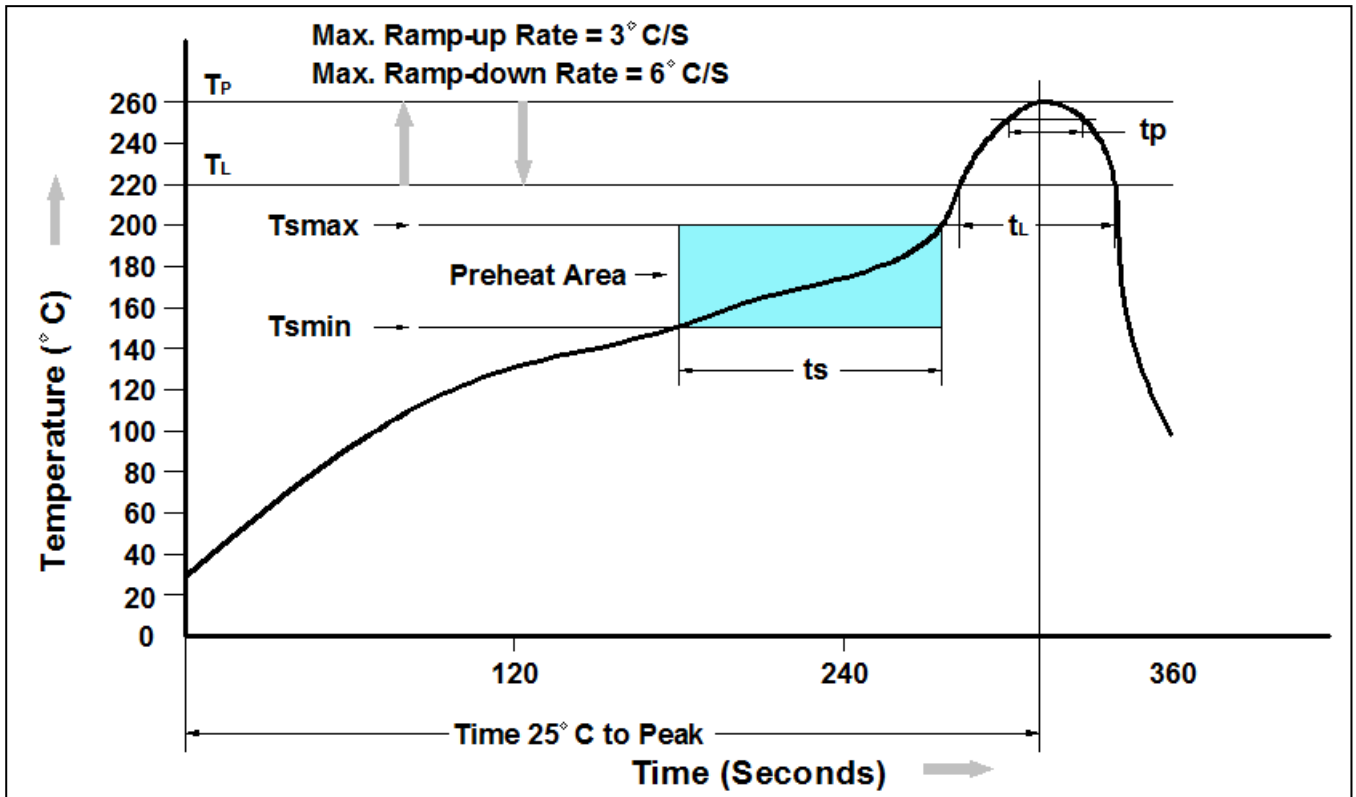

Fig.11 Unclamped Inductive Switching Waveform

➤ Recommend IR Reflow Soldering Thermal Profile



Profile Feature	Pb-Free Assembly Profile
Temperature Min. (T_{smin})	150°C
Temperature Max. (T_{smax})	200°C
Time (t_s) from (T_{smin} to T_{smax})	60-120 seconds
Average Ramp-up Rate (t_L to t_P)	3°C/second max.
Liquidous Temperature (T_L)	217°C
Time (t_L) Maintained Above (T_L)	60 – 150 seconds
Peak Temperature	260°C +0°C / -5°C
Time (t_P) within 5°C of actual Peak Temperature	30 seconds
Ramp-down Rate (T_P to T_L)	6°C/second max
Time 25°C to Peak Temperature	8 minutes max.

➤ Ordering Information

Part Number	Description	Quantity
PAN40TY24AY	DFN5X6A-EP1 Reel	3000 pcs

➤ Package Information (DFN5X6A-EP1)

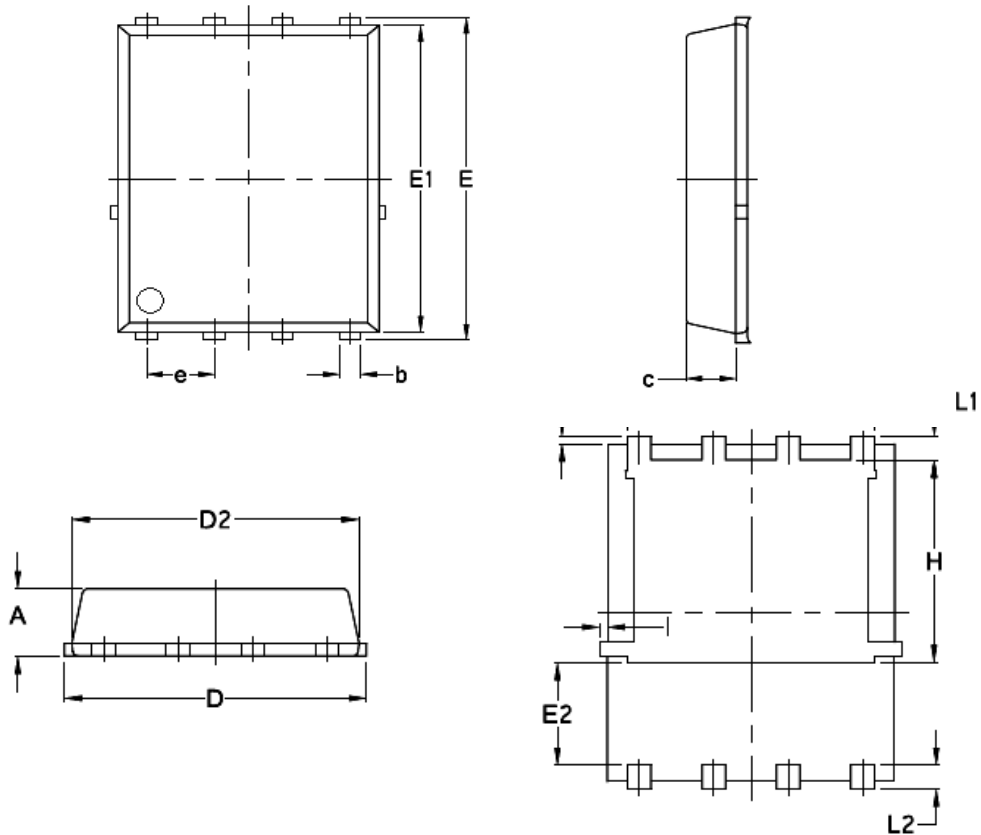

SYMBOLS	MILLIMETERS		INCHES	
	MIN	MAX	MIN	MAX
A	1.03	1.17	0.0406	0.0461
b	0.34	0.48	0.0134	0.0189
c	0.824	0.970	0.0324	0.0382
D	4.80	5.40	0.1890	0.2126
D1	4.11	4.31	0.1618	0.1697
D2	4.80	5.00	0.1890	0.1969
I	---	0.18	---	0.0070
E	5.90	6.15	0.2323	0.2421
E1	5.65	5.85	0.2224	0.2303
E2	1.10	---	0.0433	---
e	1.27 BSC		0.05 BSC	
H	3.30	3.78	0.1299	0.1488
L	0.05	0.25	0.0020	0.0098
L1	0.38	0.61	0.0150	0.0240
L2	0.38	0.71	0.0150	0.0279

DISCLAIMER

- The information in this document and any product described herein are subject to change without notice and should not be construed as a commitment by Paceleader, Paceleader reserve the right to make changes to the information in this document.
- Though Paceleader make effort to improve product quality and reliability, Product can malfunction and fail due to their inherent electrical sensitivity and vulnerability to physical stress, it is the responsibility of the customer, when utilizing Paceleader products, to comply with the standards of safety in making a safe design for entire system and to avoid situation in which a malfunction or failure., In developing a new designs, customer should ensure that the device which shown in this documents are used within specified operatingranges.
- The information contained herein is presented only as a guide for the applications of our products. No responsibility is assumed by Paceleader for any infringements of patents or other rights of the third parties which may result from its use.